

A Robotic Case Study: Optimal Design for Laparoscopic Positioning Stands

ALI FARAZ

SHAHRAM PAYANDEH

Experimental Robotics Laboratory (ERL), School of Engineering Science
Simon Fraser University, Burnaby, British Columbia, CANADA V5A 1S6
FAX : (604) 291- 4951

Abstract

The positioning stand could help the surgeon to position and lock endoscopic tools without the need for an assistant surgeon. The kinematic configuration of the positioning stand is comprised of two main parts, the arm (for positioning) and the wrist (for orienting the tool). The main requirement of the wrist is to perform spherical movements around the incision point. A concentric multi-link spherical joint design has been developed for the wrist mechanism. The size synthesis is performed to minimize the overall size of wrist and also to maximize its range of angular movements. The type synthesis of the positioning arm has led to SCARA configuration, as a balanced and easy to move arm configuration. The size synthesis of the arm is carried out with the goal of minimizing its overall dimensions, based on reachable workspace and manipulability of the arm. The integration of the wrist and arm is performed by optimizing the orientation of wrist in such a way that the interference between the wrist and the workspace of surgeon is minimized.

1. Introduction

Endoscopic surgery as a less invasive method of surgery compared to open surgery has many advantages for the patient, such as; shorter recovery time, lower risk of infection, and reduction in hospital stay/cost. On the other hand, indirect vision, limited hand movement and lack of force sensing, combined with the tiring posture of holding long tools make it a very difficult task for the surgeon to perform the operation. As a result, the surgeon has a fraction of dexterity and ability compared to open surgery.

Laparoscopic surgery is a specific branch of endoscopic surgery, that is performed on the abdomen, and endoscopic tools are passed through the incision points and trocars on the abdominal wall, so they can reach the surgical site. The abdominal wall as a kinematic constraint acts as a pivoting point that the surgeon has to move tools in a spherical configuration (i.e. 3 DOF of

angular movement around the incision point, and one translational DOF). This spherical movement of tools is the *inherent and primary* condition of laparoscopic surgery, and should be given careful attention prior to any analysis or design of tools and systems. In this paper the objective is the optimal design of passive positioning stands which can be used for positioning and locking tools/endoscopes (as described in item I in the followings), however the design can be modified and upgraded for higher level of requirements and robotic applications(i.e. item II):

I- *The Mechanical Passive Stand* : There are commercial units that can simply hold the surgical tools[e.g. Andronic Devices Ltd., U.S.Pat.No.:5,104,103]. However, the multi-arm passive stand described here, provides full support for the surgeon[Faraz, June 95] as followings : a) To position and lock endoscopic tools and camera, b) To provide a resting frame for the surgeon, c) Encoded joints with sensors can be interfaced with computer for kinematic modeling of the stand for graphical representation of the arm, wrist, and the tool for better visualization over the abdomen as well as training purposes.

II- *The Positioning Stand with Actuation* : In this kind of positioning stand, the wrist endeffector has the primary role in movement or locking of the tools. If the wrist is actuated and controlled, it could provide many new features such as automatic repositioning of the tool to the previously stored locations [Faraz, May 95] (e.g. for changing the angle of endoscope's view to a previously stored orientation)[such as AESOP commercial system by Computer Motion Inc., Goleta, Ca., USA.][also Taylor 95], or controlling the endoscopic view by simple head movement of surgeon[such as EndoSista commercial system by Armstrong Projects Ltd., Beaconsfield, England][Finlay, May 95] . Another version of actuated wrist is the teleoperated system, that the wrist as slave is controlled by a master arm which is moved by the surgeon [Faraz, June 95]. The next section covers the type/size synthesis of the

positioning stand. The wrist mechanism is type and size synthesized in section 2.1, and same steps are carried out for the arm mechanism in 2.2, and 2.3 .

2. Kinematic Synthesis of the Stand

The function of positioning stand consists of two major tasks: 1) Positioning the wrist endeffector and tool over the incision point, and 2) Orienting the tool through the incision point toward the surgical site.

The positioning is performed mainly at the beginning of procedure when the incision points are made, while orienting the tool through the incision point is performed through out the procedure. These two tasks are different both in terms of type of movement (i.e. ideally translational for positioning and rotational for orienting tool), as well as their application during the procedure. Hence an optimum design not only should be able to perform both tasks, but also to minimize or eliminate any interdependence between arms and wrists joints for the movements. To achieve this, the positioning mechanism (i.e.the arm) and orienting mechanism (i.e.the wrist) should be kinematically independent with separate mechanisms. In the following sections first the wrist and then the arm mechanisms are type and size synthesized separately.

2.1. The Wrist Endeffector

The kinematic constraints at the incision point in laparoscopic surgery allows: a) two DOF of angular movements at the incision point in the range of $\pm 70^\circ$ from the vertical axis of symmetry, b) one rotational DOF around the longitudinal axis of tool, and c) one DOF of linear movement in and out of abdomen. This spherical configuration of movement of tool is inherent to laparoscopic surgery and any design of wrist endeffector should be able to provide these degrees of freedom required for the operation [Nagy 94]. This means the wrist should have same DOF as a spherical joint at the incision point, as well as the linear movement through the incision point. Any other configuration of movement has to rely on simultaneous movement and control of at least two or more axis to simulate any movement of the spherical configuration [e.g. AESOP unit by Computer Motion Inc., Goleta, Ca., USA].

2.1.1. Type Synthesis of the Wrist

Based on the requirement of wrist, the type synthesis is limited only to those mechanisms that can provide the spherical movement as it follows:

I- Spherical joint: This is a spherical joint with socket-ball design that the tool passes through the center of joint and then through the incision point (Fig.1).

Advantages: 1) This is a compact and light design, 2)

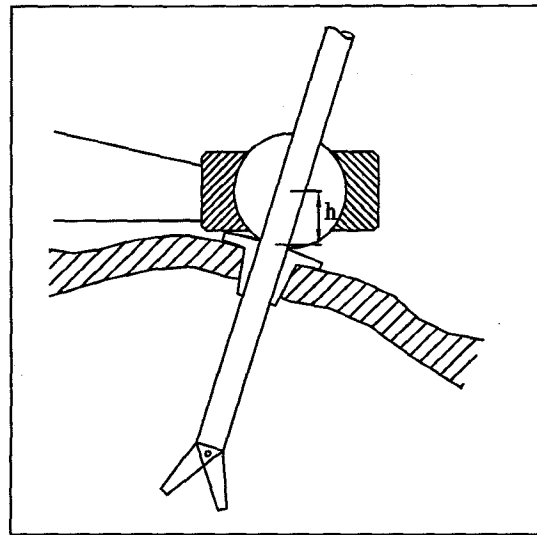

Figure 1: The wrist with spherical joint.

With minimum number of moving parts, and 3) Simple to design/manufacture.

Disadvantages: 1) Low angular range of movement (much less than the required range of $\pm 70^\circ$), 2) The center of rotation is not at the incision point, but at a distance h (Fig.1) above it. This creates difficulty to rotate the tool in the spherical joint about the incision point due to the constraint of the abdominal wall, and 3) In the case of actuated wrist, it is not very feasible to actuate the socket-ball around the three axes of rotation of the joint.

II- Spherical links: In this design the linkages are circular arc shape with the same radius, and all joints axis pass through a central point where the incision point would be located. To provide two DOF of rotational movement a four bar spherical linkage system could be designed (Fig.2).

Advantages: 1) This provides spherical movement exactly at the incision point, and 2) Adequate range of angular movement ($\pm 70^\circ$).

Disadvantages: 1) Not rigid, specially when the mechanism is extended to extreme angles, 2) Prone to clogging and difficult to manipulate due to joints clearance and linkages misalignment under load, and 3) Bulky/massive joints and linkages are required in order to increase rigidity and decrease clogging effects.

III- Concentric Multi-link Spherical Joint: This design consists of six linkages and eight rotary joints, and simulates exactly a spherical joint at the point of incision (Fig.3) with large angular range of movement in either directions. The linkages proportions and joints locations with respect to one another are in such a way that the orientation of the tool is always toward the

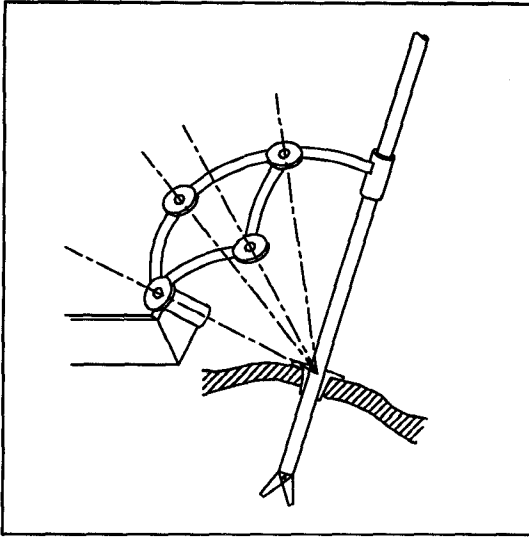

Figure 2: The wrist with spherical links mechanism.

fix point O [Hamlin 94]. Hence, the tool can be made to rotate around point O in three perpendicular directions (i.e. X,Y, and Z axes, Fig.3) just like a spherical joint. The only disadvantages could be lack of absolute rigidity due to the higher number of joints and the difficulty to manipulate when deflected to extreme angles about X-axis.

By comparing the above three types of wrist mechanisms and considering the disadvantages of each, the concentric multi-link spherical joints posses multiple advantages as a better type of wrist endeffector, hence it is size synthesized in the next section.

2.1.2. Size Synthesis of the Wrist

To determine the mechanism's size and geometry, the following parameters are needed to be specified first: L_1, L_2, L_3, L_4 and ϕ (Fig.3). The following equality constraint equations should be satisfied in order the design of concentric multi-link spherical joint [Hamlin 94] to function : $\tan \phi = \frac{L_3}{L_1}$, $L_4 = \frac{L_3}{\sin \phi}$.

As it can be seen size L_2 does not play any role in the kinematics functionality of the mechanism. However, it will be shown later that size L_2 is important in the kinetics of mechanism and the magnitudes of quasi-static forces acting on its joints under the influence of an external load. Let us consider the case when joints A and H are locked to prevent the mechanism from any movement (Fig.3). For example let external moment M be applied to the linkage GE. To find out the reaction forces of joints to the external load, we can write the equilibrium equations for links CDE and FDB, and solving them simultaneously leads to: $F_1 = \frac{M}{L_2 \sin \theta}$ and $F_2 = \frac{M}{L_4 \sin \theta}$, or $\frac{F_1}{F_2} = \frac{L_4}{L_2}$ (i.e. the joint's forces, F_1 , or F_2 approach infinity if either L_2 or L_4 approaches

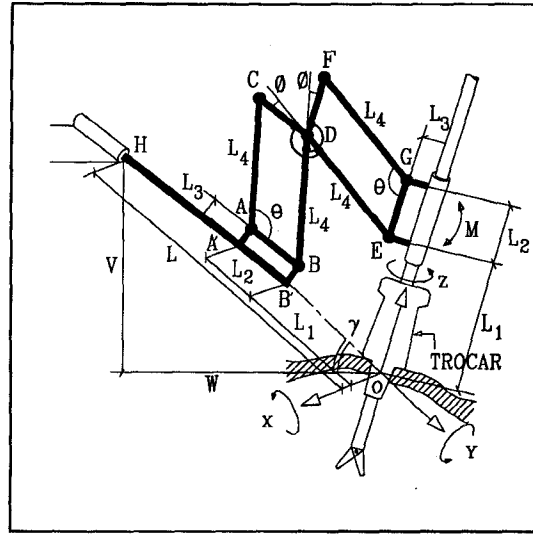

Figure 3: The concentric multi-link spherical joint

(zero). Therefore to avoid extreme joint forces, we must limit the links ratio $\frac{L_4}{L_2}$. Here, the ratio of joints forces up-to 2 is considered to be acceptable in order not to exceed the joints strength safety factor, which leads to the constraint on the links size ratio :

$$2 \geq \frac{L_4}{L_2} \geq \frac{1}{2} \quad (1)$$

Other constraints of the mechanism can be written as:

$$L_1 \geq 80^{mm}, L_3 \geq 20^{mm} \quad (2)$$

Where $L_1 \geq 80$ represents the size of trocar from point O to E (Fig.3), and $L_3 \geq 20$ represents the expected space requirements of the joints at A,B,E, and G.

The objective of this optimization is to minimize the overall size of the wrist mechanism as much as possible. One approach that the above objective can be achieved is to minimize the length OH (Fig.3). Since, $OH = OB' + A'B' + A'H$ where, $A'B' = L_2, OB' = L_1$, and to avoid interference between joints C and H when θ approaches 180° : $A'H > L_4$, hence the minimum value of OH would be:

$$OH = L_1 + L_2 + L_4 = L_1 + L_2 + \frac{L_3}{\sin \phi} = L \quad (3)$$

The objective function (3) is then solved numerically subject to the inequality constraints (1), and (2) Which yields: $L_1 = 80, L_2 = 41.2, L_3 = 20, L_4 = 82.4, \phi = 14.0^\circ$, and $L = 203.7$.

However to maximize the range of angular movement of wrist about X-axis, the angle γ should be minimized (Fig.3). Since the value of L is already known, to minimize γ means to find the minimum size of V, but in general, it is not desirable to get the lower part of arm any closer than 50 mm to the patients abdomen. As a result, by choosing $V=50$; $\gamma = 14.2^\circ$, and the projection of wrist in the horizontal plane would be: $W = 197.5mm$.

Equivalent to this planar design, Neisius (94) has also proposed a planar arm mechanism for the same function without any details. Taylor (95) has proposed a parallelogram multi-link system which geometrically is a *special case* of the design described above (when $\phi = 0$). This means for the mechanism to perform exactly as a remote spherical joint, it should have $L_3 = L_4 \sin \phi = 0$ [Hamlin 94] which poses spatial design constraints for design of joints *E* and *G* (Fig.3), in order not to interfere with the surgical tool's stem.

In addition, both of these systems [Taylor 95, Neisius 94] have been designed and intended to be used as single arm stands. Consequently, these designs (as described by the authors as arm manipulators) can not be considered as endeffectors or wrist mechanisms similar to the proposed design here, which is solely designed as a wrist mechanism, where several of them can be installed on a multi-arm stand to be used in the same limited workspace (Fig.8).

2.2. The Positioning Arm : Type Synthesis

The general requirements for the design of arm, as a passive mechanical linkage system of a multi-arm stand [Faraz, May 95][Nagy 94], are: a) to be a balanced mechanism, b) easily movable by hand, c) can be locked at any desired location, d) to occupy the least space in the operating area and not to interfere with surgeons working area, and e) not to interfere with other similar arms in the operating area.

There are infinite possibilities of mechanisms to perform the positioning task. In some positioning stands and manipulators such as HISAR surgical robot by Funda (94), redundant axes are incorporated in the design of a single arm. This can provide more flexibility and more degrees of freedom to move the arm. On the other hand, redundant axis can make the system heavier, bulkier and more difficult to manipulate since any additional axis requires stronger and heavier joints/linkages prior to that axis (consequently higher inertia, mass, gravitational and frictional forces). Here the number of axis are kept as few as possible and redundant axis can be added later if it is essential due to some specific requirement.

Basically to position the end of a manipulator/robot in a three dimensional space, at least 3 degrees of freedom are required. Table (1) shows different schematic configurations of type synthesis for 3 axes arms with rotary and/or prismatic joints.

Based on requirements a) to e) stated above, there are several mechanisms in the Table (1) that can be considered as good candidates such as No.12, 13, and 41. No.12 and 13 are different configurations of three prismatic joints arms (PPP) that X and Z axis are horizontal, so can be moved easily (since gravitational

PPP			
PPR			
PRP			
PRR			
RPP			
RPR			
RRP			
RRR			

Table 1 - The schematic of 3DOF arms.

forces do not have any components in these directions of movements). In addition Y axis could be balanced by use of balancing systems (e.g. weight pulleys/ pneumatic weight compensators/electric motor balancing systems) or by using self locking lead screw since motion along Y axis is not executed often. The disadvantage of No.12 and 13 is that prismatic joints can become bulky/massive, and can introduce higher frictional/inertial forces than rotary joints. In addition, both designs are overhead mount, that makes them less attractive from point of view of portability, ease of installation, and maintenance.

The design No.41, on the other hand is a (PRR) SCARA configuration where the two rotary joints are parallel along the vertical Y axis. The arm is naturally balance and can be moved in horizontal plane which is parallel to the surface of the operating table. The linkages of the arm can be selected to be short, light, with rotary joints which create low friction for manual movements. All these make the SCARA configuration very attractive for this application (however, not the only possible solution), which will be considered for

size synthesis in the next section.

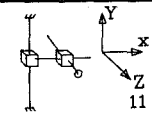
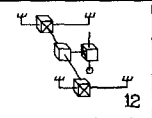
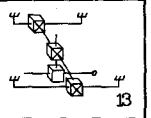
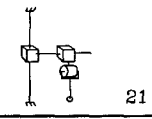
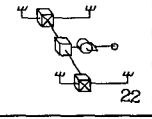
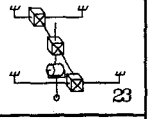
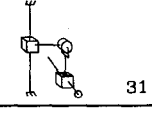
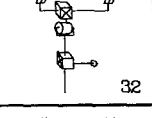
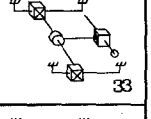
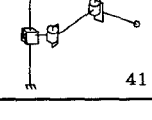
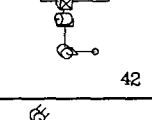
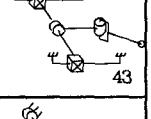
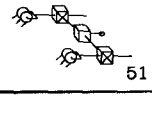
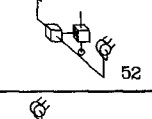
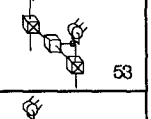
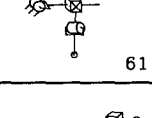
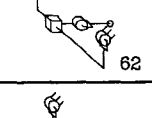
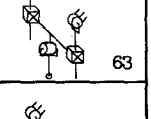
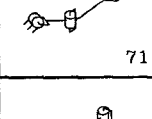
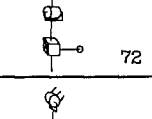
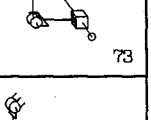
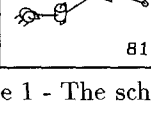
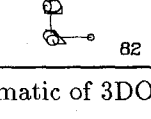
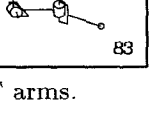
2.3. Size Synthesis of the Arm

In general an operating work space with a rectangular shape of 500×350 mm can be chosen, which can be divided equally in to two areas of 250×350 for each arm(left and right). The surgeon is on the opposite side of the operating table that uses each arm by one of his hands(Fig.8). The surgeon in general should be able to manipulate the arms to the desired positions easily and also the arms' dimensions should allow them to reach their entire work space. To satisfy these requirements, in the next two sections, two main topics of manipulability and reachability of the arms are studied.

2.3.1. Manipulability Measure

The ease of movement of the passive arms by surgeon's hands depends not only on the friction at each joint, but also on the configuration of arm and the size of linkages. The purpose of this section is to study manipulability of the arm and isotropy of manipulating forces, to optimize the arms design.

There are several works in the literature that are related to our application with well known concepts such as *manipulability*[Yoshikawa 85, Lee 93], *Kinematic Dexterity*[Park 94], and *isotropy* of manipulating forces[Klein 91]. These concepts have evolved based on the *Jacobian* matrix of manipulator and the *conditioning index/number* of the matrix. However, the conditioning index of Jacobian matrix does not represent any physical design parameter. In this section, a new measure of manipulability (which is the ratio of maximum and minimum manipulating forces) is derived as a physical interpretation of the conditioning index, to the special case of the passive arm with constant frictional torque at the joints.

The basic notion is that at singularity, a design of a mechanism loses at least one DOF, and this happens when the determinant of Jacobian approaches zero. For two links mechanism(Fig.4), the Jacobian would be:

$$J = \begin{bmatrix} -L_1 \sin \theta_1 + L_2 \sin(\theta_2 - \theta_1) & L_2 \sin(\theta_2 - \theta_1) \\ L_1 \cos \theta_1 + L_2 \cos(\theta_2 - \theta_1) & L_2 \cos(\theta_2 - \theta_1) \end{bmatrix}$$

and $\det(J) = -L_1 L_2 \sin \theta_2 = 0 \Rightarrow \theta_2 = 0, \text{ and } \pi$.

The manipulability measure (m) for a non-redundant mechanism is the absolute value of Jacobian's determinant[Yoshikawa 85, Lee 93]: $m = |\det(J)|$. Therefore at $\theta_2 = 0$ and π , the manipulability would be zero. Also the arm is not manipulated easily due to lack of isotropy(i.e. non-uniformity of manipulating forces at different directions) as we get close to the singularity points[Salisbury 82, Gosselin, and Angeles 91]. So not only the singularity points (i.e. $\theta_2 = 0, \pi$) must be

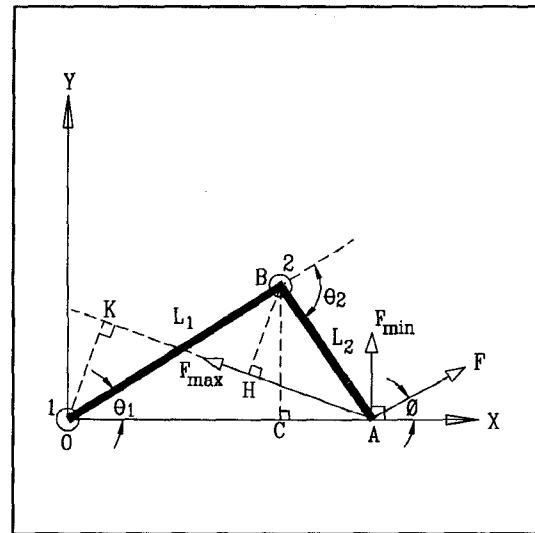

Figure 4: Manipulating forces acting on the arm.

avoided, but also θ_2 should be limited to the range that the manipulability of the two link system is in an acceptable range. To formulate this, let us consider joint torques relationship: $\tau = J^T F$, where F is the applied hand force acting at the end of arm, at an angle ϕ (Fig.4) :

$$\begin{bmatrix} \tau_1 \\ \tau_2 \end{bmatrix} = [J]^T \begin{bmatrix} F \cos \phi \\ F \sin \phi \end{bmatrix} \quad (4)$$

The reaction torque at joints 1 and 2 are basically Coulomb frictional torque (e.g. mainly due to the sealing rings of the pneumatic brakes of the joints) and their maximum limit can be considered to be τ_{max} (so $|\tau_1|$ and $|\tau_2| \leq \tau_{max}$). Hence the minimum force required (in any direction) to move either joints 1 or 2 by producing enough torque(τ_{max}) depends on the normal distance of acting force F , to the joint(Fig.4). To find the minimum and maximum forces to move the arm, the following cases are considered:

1) Case $OA \geq AB$: In this case joint 1 is the first joint to move since it has the longest arm from the manipulating force (i.e. OA, Fig.4). To find the magnitude and direction of the minimum force (F_{min}) that can move joint 1, we have (from Eq.(4)):

$$\tau_1 = \tau_{max} = F \cos \phi [-L_1 \sin \theta_1 + L_2 \sin(\theta_2 - \theta_1)] + F \sin \phi [L_1 \cos \theta_1 + L_2 \cos(\theta_2 - \theta_1)]$$

Since $L_1 \sin \theta_1 = L_2 \sin(\theta_2 - \theta_1)$ ($=BC$ in Fig.4), then the above equation reduces to:

$$F = \frac{\tau_{max}}{\sin \phi [L_1 \cos \theta_1 + L_2 \cos(\theta_2 - \theta_1)]} \quad (5)$$

Here F_{min} happens when $\phi = \pm \frac{\pi}{2}$, and by substituting this in (5) :

$$F_{min} = \frac{\tau_{max}}{L_1 \cos \theta_1 + L_2 \cos(\theta_2 - \theta_1)} \quad (6)$$

On the other hand, the maximum force (F_{max}) required to move joint 1 or/and 2 should have the minimum distance from joint 1 and 2 (BH=OK, Fig.4). Any other direction makes the perpendicular distance of force F from either joint 1 or 2 more than BH or OK. Consequently the force required to produce torque τ_{max} around that joint would be less than F_{max} . The angle of F_{max} (i.e. ϕ_{max} where BH=OK, Fig.4) can be obtained analytically by inserting $\tau_1 = \pm\tau_{max}$ and $\tau_2 = \mp\tau_{max}$ in (4) to obtain following equations:

$$\pm\tau_{max} = F_{max} \sin \phi_{max} [L_1 \cos \theta_1 + L_2 \cos(\theta_2 - \theta_1)]$$

$$\mp\tau_{max} = F_{max} L_2 \sin(\theta_2 - \theta_1 + \phi_{max})$$

by dividing the above equations and simplification, we get:

$$\cot \phi_{max} = -2 \cot(\theta_2 - \theta_1) - \cot(\theta_1) \quad (7)$$

Yoshikawa(85) stated the optimum linkage size for manipulability of a two link system is when $L_1 = L_2$ (this is also confirmed in the development of section 2.3.2), that leads to: $\theta_1 = \theta_2/2$ (Fig.4). By substituting this in (7):

$$\cot \phi_{max} = -3 \cot(\theta_2/2) \quad (8)$$

Also from (5):

$$F_{max} = \frac{\tau_{max}}{\sin \phi_{max} [L_1 \cos \theta_1 + L_2 \cos(\theta_2 - \theta_1)]} \quad (9)$$

The ratio of (9) over (6) would be:

$$\frac{F_{max}}{F_{min}} = \frac{1}{\sin \phi_{max}} \quad (10)$$

And by substituting (8) in (10), the ratio of maximum and minimum manipulating forces when $OA \geq AB$ can be obtained as:

$$\frac{F_{max}}{F_{min}} = \sqrt{1 + 9 \cot^2(\theta_2/2)} = \frac{\sqrt{2(1 + \cos \theta_2)(5 + 4 \cos \theta_2)}}{\sin \theta_2} \quad (11)$$

II) Case $OA \leq AB$: In this case joint 2 is the first joint to move. The magnitude and direction of the minimum force that moves joint 2 with torque τ_{max} according to equation (4) is: $\tau_2 = \tau_{max} = F L_2 \sin(\theta_2 - \theta_1 + \phi)$, hence:

$$F = \frac{\tau_{max}}{L_2 \sin(\theta_2 - \theta_1 + \phi)} \quad (12)$$

And F_{min} happens when $\sin(\theta_2 - \theta_1 + \phi) = 1$:

$$F_{min} = \frac{\tau_{max}}{L_2} \quad (13)$$

The magnitude and direction of F_{max} can be established in the same way as the previous case, which also leads to equations (8) and (9). So the ratio of maximum and minimum forces when $OA \leq AB$, for the case $L_1 = L_2$ and $\theta_1 = \theta_2/2$ would be:

$$\frac{F_{max}}{F_{min}} = \frac{\sqrt{1 + 9 \cot^2(\theta_2/2)}}{2 \cos(\theta_2/2)} = \frac{\sqrt{5 + 4 \cos \theta_2}}{\sin \theta_2} \quad (14)$$

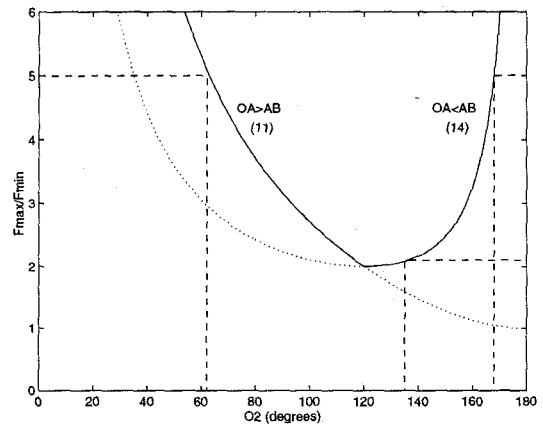

Figure 5: F_{max}/F_{min} vs. θ_2

$\frac{F_{max}}{F_{min}}$ as a new local measure of manipulability (or isotropy) is plotted against θ_2 in Fig.5, to able the designer to choose the best range of θ_2 that the isotropy of manipulating forces is in the acceptable range. For the design of the positioning arm, let the initial range of the above manipulability measure to be: $5 \geq \frac{F_{max}}{F_{min}} \geq 2$

According to Fig.5, this leads to the following range of θ_2 based on equations(11), and(14): $168^\circ \geq \theta_2 \geq 60^\circ$. However, the higher range of $\theta_2 = 168^\circ$, due to the orientation of wrist (it will be discussed later, section 2.3.3), can not increase more than 135° . Therefore the final range of θ_2 that would be acceptable for the local manipulability as well as the wrist orientation would be: $135^\circ \geq \theta_2 \geq 60^\circ$.

2.3.2. Reachability Optimization

The objective of this section is to minimize the arm's size while it still can reach the operating area of $350 \times 250mm$ subject to the manipulating/ orientation constraint $135^\circ \geq \theta_2 \geq 60^\circ$.

The variables of this optimization are the arm's base position (a and b), and arm's linkages (L_1 and L_2 , Fig.6). For a given position and linkage variables (i.e. a , b , L_1 , and L_2), the arm (ABC) to reach the farthest point (M or N), then:

$$|\vec{R}(\theta_2 = 60^\circ)| \geq \text{MAX}(AM \text{ or } AN), \text{ This leads to :}$$

$$L_1^2 + L_2^2 + L_1 L_2 \geq \text{MAX}[a^2 + (b+350)^2, (250-a)^2 + (b+350)^2] \quad (15)$$

To reach the nearest point (P):

$$|\vec{R}(\theta_2 = 135^\circ)| \leq AP, \text{ This leads to :}$$

$$L_1^2 + L_2^2 - \sqrt{2} L_1 L_2 \leq b^2 \quad (16)$$

These two inequality constraints (15, and 16) ensures that, the arm can reach all the points in its workspace without violating the manipulability constraint $135^\circ \geq \theta_2 \geq 60^\circ$. The objective function for this optimization

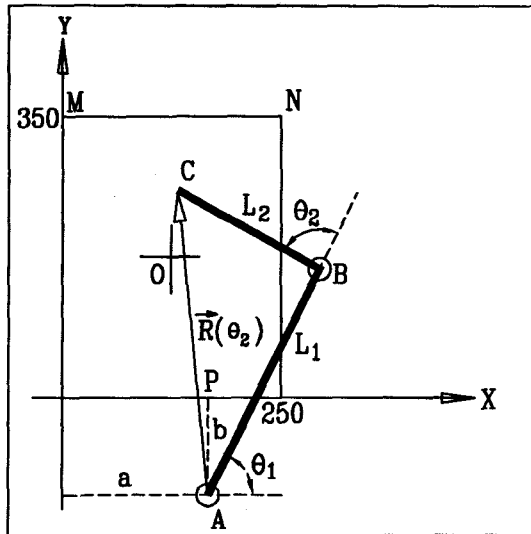

Figure 6: The arm's variables(a , b , L_1 , and L_2 .)

is to minimize the overall size of the arm. One way of achieving this is by minimizing the distance of the base point A from the central point of the workspace(i.e. point O, Fig.6). Hence The objective function can be formulated as :

$$MIN : f(a, b) = AO^2 = (a - 125)^2 + (b + 175)^2 \quad (17)$$

Subject to the inequality constraints (15) and (16), the results are: $a = 125$, $b = 287$, $L_1 = L_2 = 375\text{mm}$.

2.3.3. The Wrist Orientation

To minimize the interference of the wrist mechanism in the operating area with the hands movement of surgeon, ideally it is desired to have the orientation of wrist(W) always pointing toward the surgeon at point S (Fig.7). In other words, it is best to have the wrist mechanism(W) in such an orientation that it is always located on the opposite side of surgeon when the incision point(C) is considered as the center point in between[Nagy 94]. Ideally the joint D could be an actuated joint, so that angle α could be controlled based on the configuration of the arm in such a way that wrist W always points toward the surgeon while point C is moved.

On the other hand, joint D could be considered as a fix joint with constant angle α , if the deviation of its orientation is in an acceptable range (e.g. $\pm 45^\circ$) for the whole operating range in the workspace. This could be verified by finding the fix value of α , β , and L_2 when C is at the center of operating area while W is pointing toward S (where $x_s = 0$ and $y_s = 500$). Using the optimized values of a , b , L_1 , L_2 , and W from previous sections, and using basic geometric analysis we can obtain : $\alpha = 58^\circ$, $\beta = 27^\circ$, $L_2' = 228$

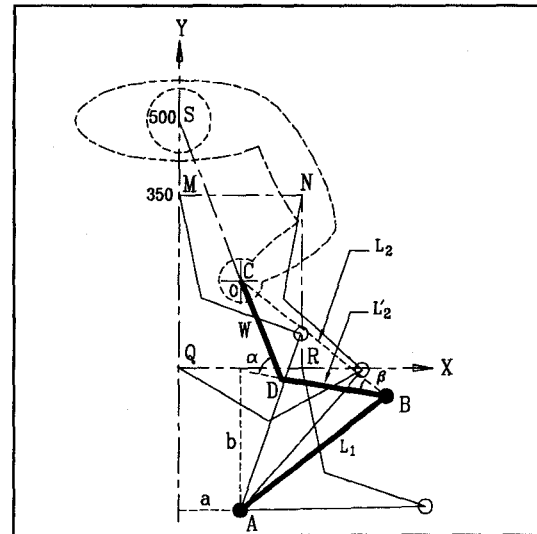

Figure 7: The wrist with orientation toward point S.

As shown in Fig.7, the orientation of wrist does not deviate substantially(in the maximum order of $\pm 45^\circ$ for extreme points of the operating area (e.g. points M,N,Q, and R). Also wrist W does not interfere with the operating area of the other arm when approaching the symmetrical axis of Y. Therefore for a passive positioning arm, a fix joint at D at constant angle α could be considered as an optimum and also the simplest solution.

3. Summary and Conclusions

The function of positioning stand mainly consists of: a) Positioning the wrist by the arm, b) Orienting the tool by the wrist. Due to separate tasks that the wrist and arm perform, and also to make them kinematically independent/decoupled, they are designed as separate mechanisms.

The wrist: Due to the spherical motion requirement and the nature of tool's movement in Laparoscopic surgery, the wrist must simulate spherical movements at the incision point. For this purpose, the concentric multi-link spherical joint is found to be the most suitable mechanism. The size synthesis of the wrist is carried out by minimizing the overall size of the wrist as well as maximizing its range of movement.

The arm: In order to position the arm over the incision point manually, it must be well balanced, easy to move, occupy the least space, and not to interfere with surgeon working area or other similar arms. SCARA configuration is chosen in this case to be a suitable type for the arm, and a new measure of manipulability(Eq.s 11, and 14) for the passive manipulator is developed. The size synthesis of arm is carried out by minimizing their overall size while satisfying the manipulability measure, and also reaching the required

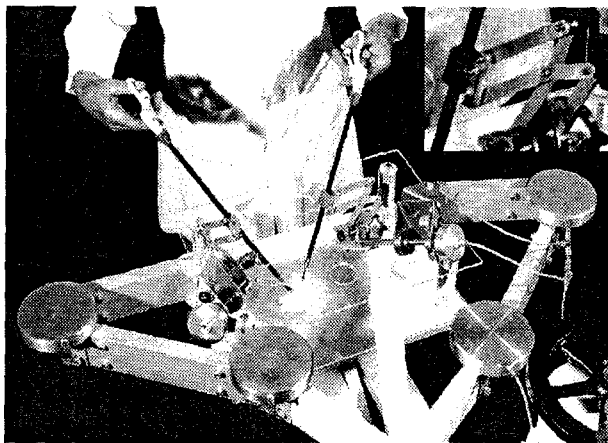

Figure 8: The passive laparoscopic stand.

workspace .

In addition the wrist orientation is optimized to such an angle that it remains out of the way on the opposite side of incision point with respect to the surgeon. This could eliminate the interference of the wrist with the surgeon's working area and other arms.

In the final integration of the arm and wrist, at least two integrated arm could work side by side without interference as can be seen in the implemented system at SFU-ERL(Fig.8). Also additional arms in a higher plane (to eliminate any possibility of interference with the two main arms mentioned earlier) could provide positioning possibility for other tools such as the endoscope for vision systems. The implemented system as the first multi-arm surgical positioning device which is going under experimental clinical trial, shows the potential to be practical, and provide the total environment needed to perform "solo-surgery".

The proposed design could be used for full robotic master/slave teleoperated system[Faraz, May 95] that the wrist is actuated/controlled by a master arm that is moved by the surgeon hand (under development at SFU-ERL).

4. Acknowledgments:

The authors would like to thank the financial support of The Institute for Robotics and Intelligent Systems (IRIS), A Federal Networks of Centres of Excellence, as well as contributions of Dr. Nagy for facilitating the clinical evaluation, and SFU machine shop for the development.

5. References

- Faraz, A., Payandeh, S., Nagy, A., June 1995, "Issues and Design Concepts in Endoscopic Extenders", *Proc. 6th IFAC Symp. on MMS*, MIT, pp. 109-114.
- Faraz, A., Payandeh, S., May 1995, "Application of Robotics In Endoscopic Surgery", *Proc. 15th Canadian*

Congress of Applied Mechanics, Vol.1, pp.252-253.

- Finlay, P.A., Ornstein, M.H., May/June 1995, "Controlling the Movement of a Surgical Laparoscope", *IEEE Engineering in Medicine and Biology Magazine*, Vol.14, No.3, pp.289-291.
- Funda, J., Eldridge, B., Gruben, K., Gomory, S., Taylor, R., 1994, "Comparison of Two Manipulator Designs for Laparoscopic Surgery", *Telemanipulator and Telepresence Technologies*, SPIE, Vol.2351, pp.172-183.
- Gosselin, C., Angeles, J., Sept.1991, "A Global Performance Index for the Kinematic Optimization of Robotic Manipulators", *Transactions of ASME, Journal of Mechanical Design*, Vol.113, pp 220-226.
- Hamlin, G.J., Sanderson, A.C., 1994, "A Novel Concentric Multi-link Spherical Joint with Parallel Robotics Applications", *IEEE*, pp.1267-1272.
- Klein, A.K., Miklos, T.A., 1991, "Spatial Robotic Isotropy", *The International Journal of Robotics Research*, Vol.10, No.4, pp.426-437.
- Lee, M.Y., Erdman, A.G., Gutman, Y., Sept.1993, "Development of Kinematic/ Kinetic Performance Tools in Synthesis of Multi-DOF Mechanisms", *ASME Trans., J. Mechanical Design*, Vol.115, pp 462-472.
- Nagy, A., Head of Laparoscopic Surgery, Department of Surgery, University of British Columbia, and Vancouver General Hospital, 1994, *Personal Communications*.
- Neisius, B., P.Dautzenberg, R.Trapp, 1994, "Robotic Manipulator for Endoscopic Handling of Surgical Effectors and Cameras" *First International Symposium on Medical Robotics and Computer Assisted Surgery (MRCAS)*, pp.1-7.
- Park, F.C., Brockett, R.W., 1994, "Kinematic Dexterity of Robotic Mechanisms" *The International Journal of Robotics Research*, Vol.13, No.1, pp.1-15.
- Salisbury, J.K., Craig, J.J., 1982, "Articulated Hands: Force Control and Kinematic Issues", *Int. J. Robotics Research*, Vol.1, No.1 pp.4-17.
- Taylor, R.H., Funda, J., Eldridge, B., Gruben, K., Gomory, LaRose, D., Talamini, M., Kavoussi, L., Anderson, J., May/June 1995, "A Telerobotic Assistant for Laparoscopic Surgery", *IEEE Engineering in Medicine and Biology Magazine*, Vol.14, No.3, pp.279-288.
- Yoshikawa, T., Summer 1985, "Manipulability of Robotic Mechanisms", *The International Journal of Robotics Research*, Vol.4, No.2, MIT, pp.3-9.